

LOAD TRANSFER STATION

1. The pallet load is placed in the station and the forks withdrawn from the pallet.

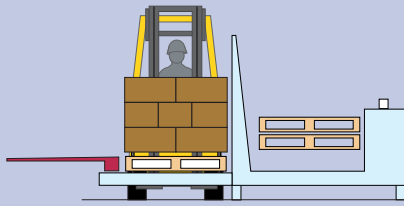

2. The unit cycle switch, or radio controlled cycle switch, is actuated and the station automatically removes and stacks the pallets.

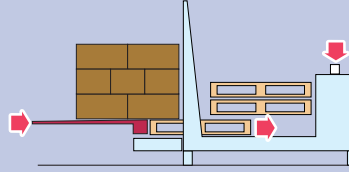

3. The shipping pallet, slipsheet or bare platens are placed directly under the transfer plate for receiving the load on the narrow facing.

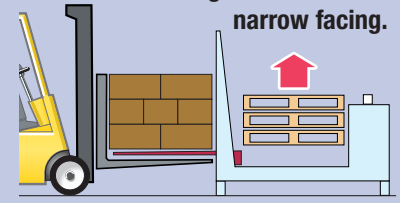

3a. The shipping pallet may also be positioned for receiving the load on the wide facing.

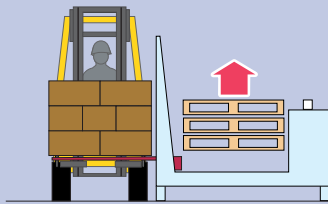

4. The unit cycle switch or radio controlled cycle switch is again actuated. The transfer plate slides out from under the load, transferring it to the receiving lift truck.

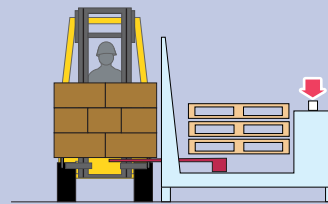

5. Once the transfer plate is completely withdrawn, the truck is free to proceed with the load.

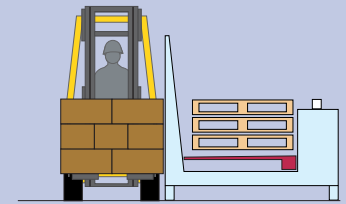

Significant cost savings by keeping your pallets "captive".

APPLICATIONS

The Load Transfer Station removes loads from your pallets and makes them available for transfer to slipsheets, less expensive shipping pallets, customer pallets or directly to push/pull platens for floor loading. Shipping on slipsheets or floor loading also allows you to substantially reduce pallet inventories, along with the associated costs of pallet storage, maintenance and retrieval.

FEATURES

- Loads are transferred by retracting a smooth steel plate, the load is set on the load base (pallet, slipsheet or platens)
- Pallets are protected by pressure sensitive sequencing
- Transfer stations can be used in nearly any application using 40" x 40" to 48" x 48" size pallets
- Load transfer stations gives you the ability to select the shipping method right at the dock
- Loads may be placed from two sides and received from three sides
- Load transfer station work with a combination of standard fork trucks and push/pull equipped trucks
- Radio control transmitter allows the station to be actuated from the lift truck or a fixed wall location
- Mobile option allows the unit to be easily moved to other predetermined locations

OPTIONS

- Service kit contains a complete selection of service items, such as cylinder seals and replacement bearings
- Audio Alarm
- Automatic Pallet Dispenser—Replaces in-house pallet with less expensive shipper pallet



An excellent method of transferring loads to captive pallets at the receiving dock.

LOAD TRANSFER STATION

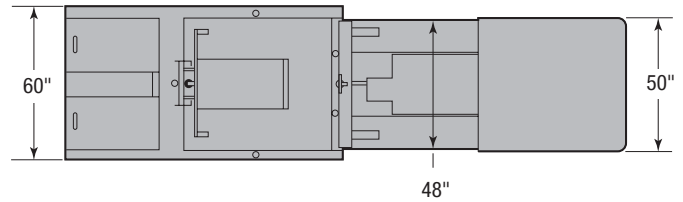
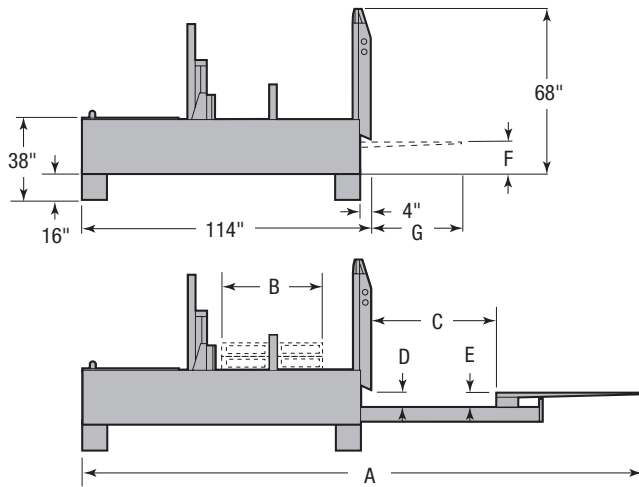

Catalog Order No.	Pallet Size Handled (L x W)	Load Capacity (lbs.)	Extended Length	Pallet Stack Width	Load Platform Width	Vertical Pallet Opening ①	Deck to Plate Height ①	Transfer Plate Height ①	Transfer Plate Width	Weight (lbs.)	Electrical Supply (Three Phase Required)
			A	B	C	D	E	F	G		
40A-LTS-01N	48" x 40"	4,000	226"	40"	50"	5.0" to 7.0"	4.7" to 5.7"	10.7" to 11.7"	41"	5,000	220 volts 23 amps
40A-LTS-02N	44" x 48"		234"	48"	58"				49"		
40A-LTS-03N	42" x 42"		228"	42"	52"				43"		
40A-LTS-04N	40" x 48"		234"	48"	58"				49"		
40A-LTS-11N	48" x 40"		226"	40"	50"				41"		
40A-LTS-12N	44" x 48"		234"	48"	58"				49"		
40A-LTS-13N	42" x 42"		228"	42"	52"				43"		
40A-LTS-14N	40" x 48"		234"	48"	58"				49"		

① These components may be adjusted to meet exact load and pallet size requirements

Notes

1. The user supplies the electrical cord and plugs to insure compatibility with their electrical system.
2. The Load Transfer Station must be secured at each operating location by a floor bolt or by a hold-down floor bracket.
3. Maximum pallet stacking capacity is 20 pallets.

ADDITIONAL FEATURES

- Strobe warning light indicates transfer plate or stacker motion
- Heavy duty limit switches for reduced maintenance

Easy to Install

All of the electrical and hydraulic components are self contained in the unit. The only installation requirement is a three phase 220- or 440-volt electrical supply, the necessary cords and plugs to connect the electrical supply, and a bolt or latching system to secure the unit to the floor.

